

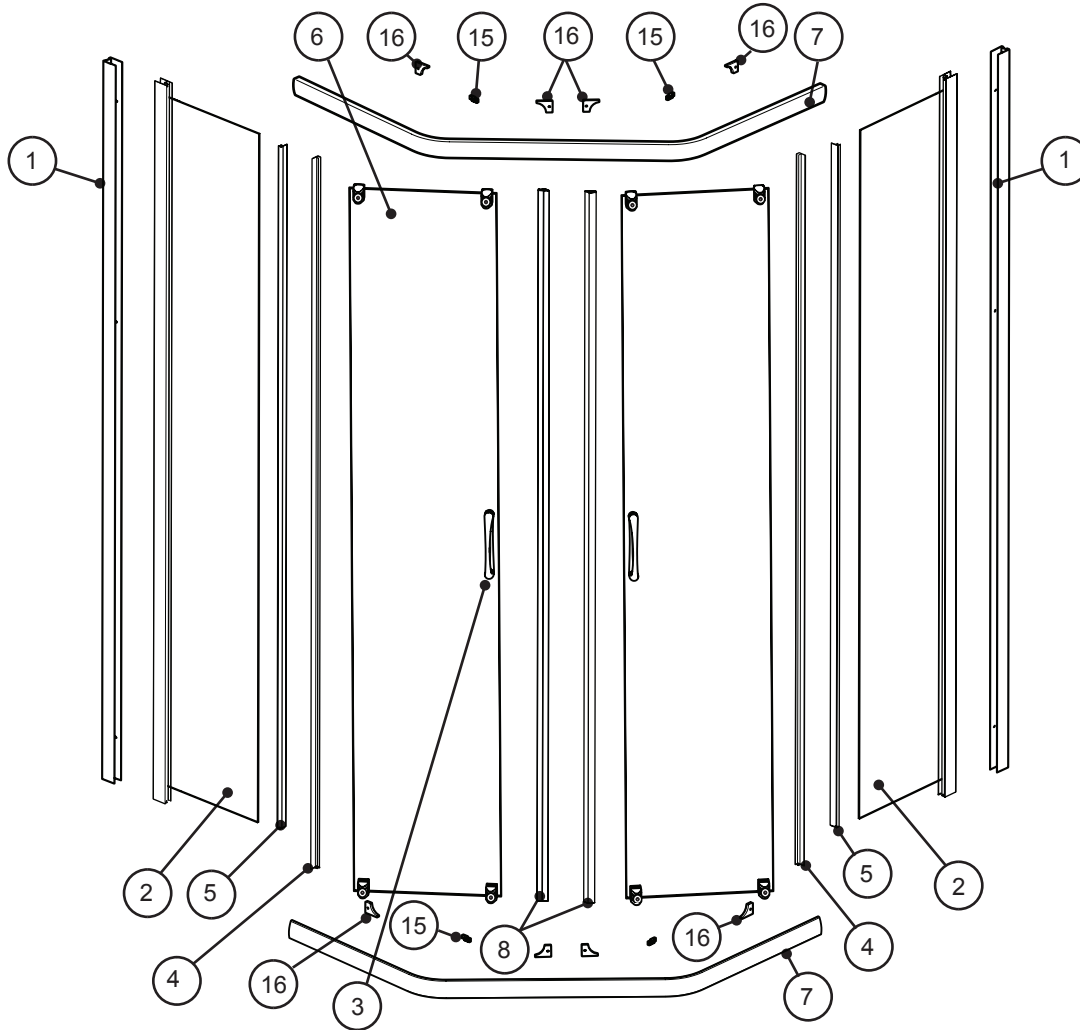





PARTS LISTING / LISTE DES PIÈCES



HARDWARE / QUINCAILLERIE

- 9 
- 10 
- 11 
- 12 
- 13 
- 14 

ITEM	PARTS - PIÈCES	QTY
1	WALL JAMB - JAMBAGE	2
2	SIDE PANEL WITH EXPANDER - PANNEAU FIXE AVEC EXTENSEUR	2
3	HANDLE - POIGNÉE	2
4	DOOR SIDE GASKET - JOINT LATÉRAL DE PORTE	2
5	SIDE PANEL GASKET - JOINT LATÉRAL POUR LE PANNEAU FIXE	2
6	DOOR PANEL ASSEMBLY - ASSEMBLÉ DE PORTE	2
7	TOP AND BOTTOM TRACK - RAIL SUPÉRIEUR ET INFÉRIEUR	2
8	MAGNETIC DOOR GASKET - JOINT MAGNÉTIQUE	2
ITEM	HARDWARE - QUINCAILLERIE	QTY
9	WALL PLUG - CHEVILLE # 6-1	6
10	SCREW - VIS 3/8"	6
11	SCREW - VIS 1 3/8"	14
12	SCREW - VIS 1/4"	4
13	SCREW CAP - CAPUCHON COUVRE-VIS	6
14	BACK SCREW CAP - L'ARRIÈRE DU CAPUCHON	6
15	GLASS SUPPORT - SUPPORT DE VERRE	4
16	BUMPER & SCREWS - BUTÉE & VIS	8