

B034

Tub shield / *Écran de baignoire*

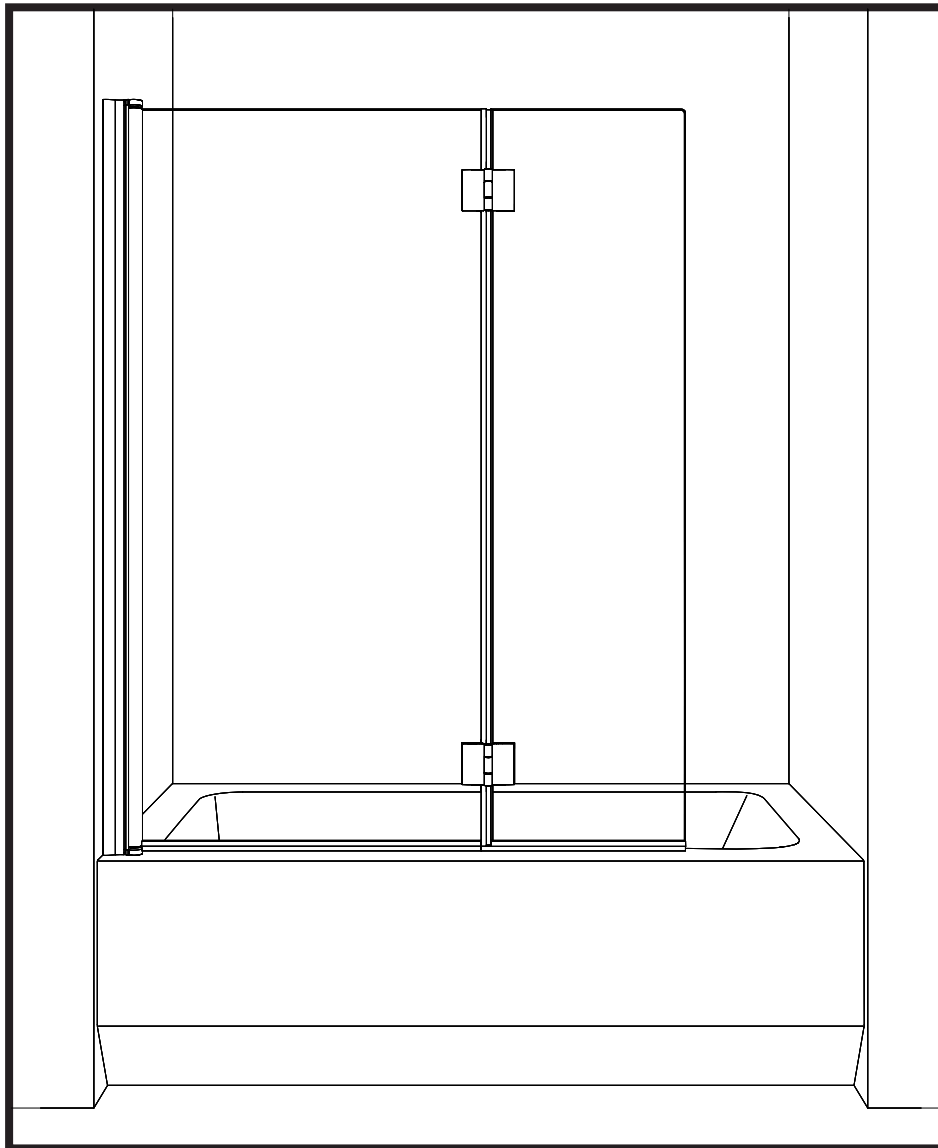

Please keep this manual and product code number for future reference
and for ordering replacement parts if necessary.

*Veuillez conserver ce manuel et le code de produit pour des références futures,
et au besoin, la commande de pièces de rechange.*

GENERAL INSTRUCTIONS

- Read this manual carefully and completely before proceeding.
- It is recommended that you wear safety glasses at all times during the installation.

En

INSTALLATION OVER CERAMIC TILES

- If your shower door is to be installed over ceramic tiles, the tiles should lay completely under the wall jamb.
- Silicone should be used to seal the gap where the ceramic tiles meet the fixed panel.

NOTICE

- Caulking: no sealant is required inside the shower, unless otherwise stated.
- Some models are equipped with clear sealing gaskets.

CARE FOR YOUR SHOWER DOOR

- Never use scouring powder pads or sharp instruments on metal pieces or glass panels. An occasional wiping down with a mild soap diluted in water is all that is needed to keep the panels and aluminum parts looking new.
- We recommend wiping the glass panels with a squeegee after each use.

INSTRUCTIONS GÉNÉRALES

- Lire attentivement et complètement le manuel d'installation avant de procéder.
- Il est recommandé de porter des lunettes de sécurité en tout temps lors de l'installation.

Fr

INSTALLATION SUR LES TUILES EN CÉRAMIQUE

- Si votre porte de douche doit être installée sur une bordure en céramique, le jambage doit reposer complètement sur cette dernière.
- Le calfeutrage doit être appliqué sur le côté extérieur de la douche où le panneau fixe rencontre la bordure en céramique.

NOTE

- Calfeutrage: aucun scellant n'est nécessaire à l'intérieur de la douche.
- Certains modèles sont dotés de joints d'étanchéité clairs.

L'ENTRETIEN DE VOTRE DOUCHE

- Ne jamais utiliser de poudre ou de tampon à récurer, ni d'instrument tranchant sur les parties en métal ou en verre. De temps à autre, il suffit de nettoyer la porte avec une solution d'eau et un détergent doux pour conserver l'aspect neuf des panneaux de verre et du cadre en aluminium.
- Nous recommandons de passer une raclette de douche sur les panneaux de verre après chaque utilisation.

TOOLS REQUIRED / OUTILS REQUIS

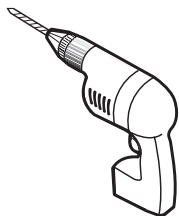

DRILL
PERCEUSE

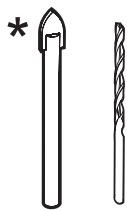

1/4" & 1/8" DRILL BITS
MÈCHE 1/4" & 1/8"

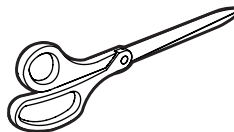

SCISSORS
CISEAUX



MALLET
MAILLET



PENCIL
CRAYON



TAPE MEASURE
RUBAN À MESURER

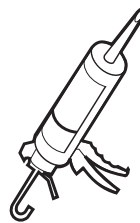

SILICONE
SCCELLANT

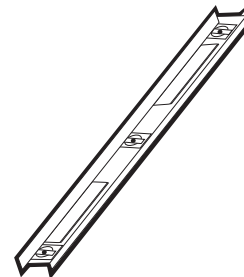

LEVEL
NIVEAU

* USE A 1/4" DRILL BIT FOR CERAMIC WHEN DRILLING INTO CERAMIC TILES
* UTILISER UNE MÈCHE DE 1/4" DESTINÉ À CÉRAMIQUE LORS DU PERÇAGE DES TUILES EN CÉRAMIQUE.

POSSIBLE CONFIGURATIONS / CONFIGURATIONS POSSIBLES

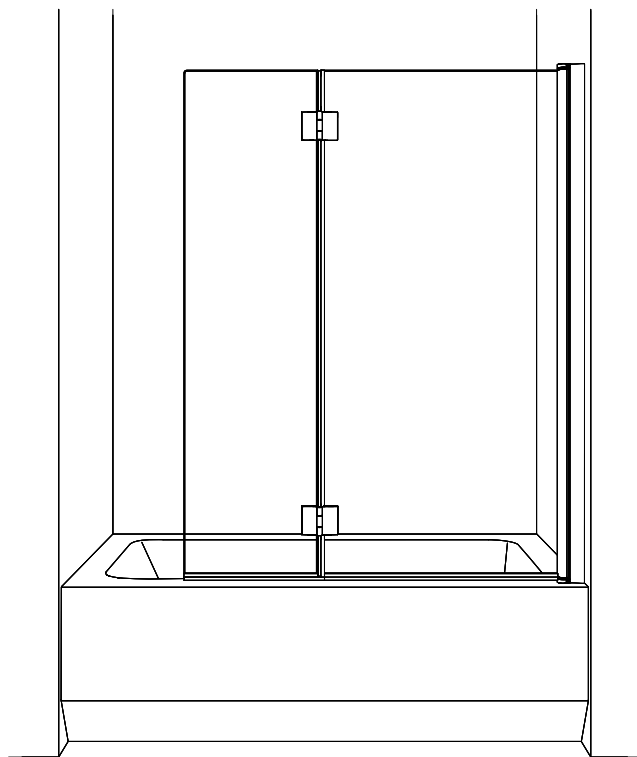
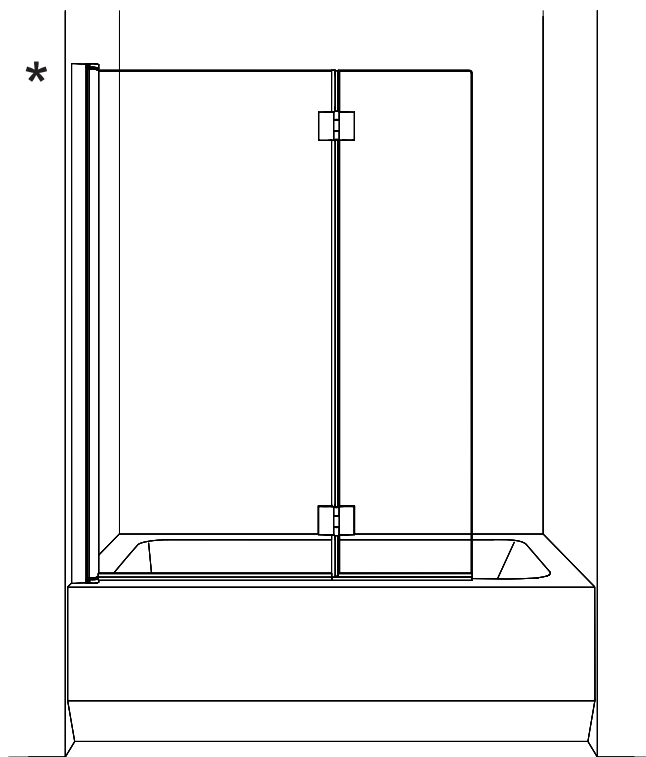

* THIS CONFIGURATION IS ILLUSTRATED IN THE MANUAL.
* CETTE CONFIGURATION EST ILLUSTRÉE DANS CE MANUEL.

PARTS LISTING / LISTE DES PIÈCES

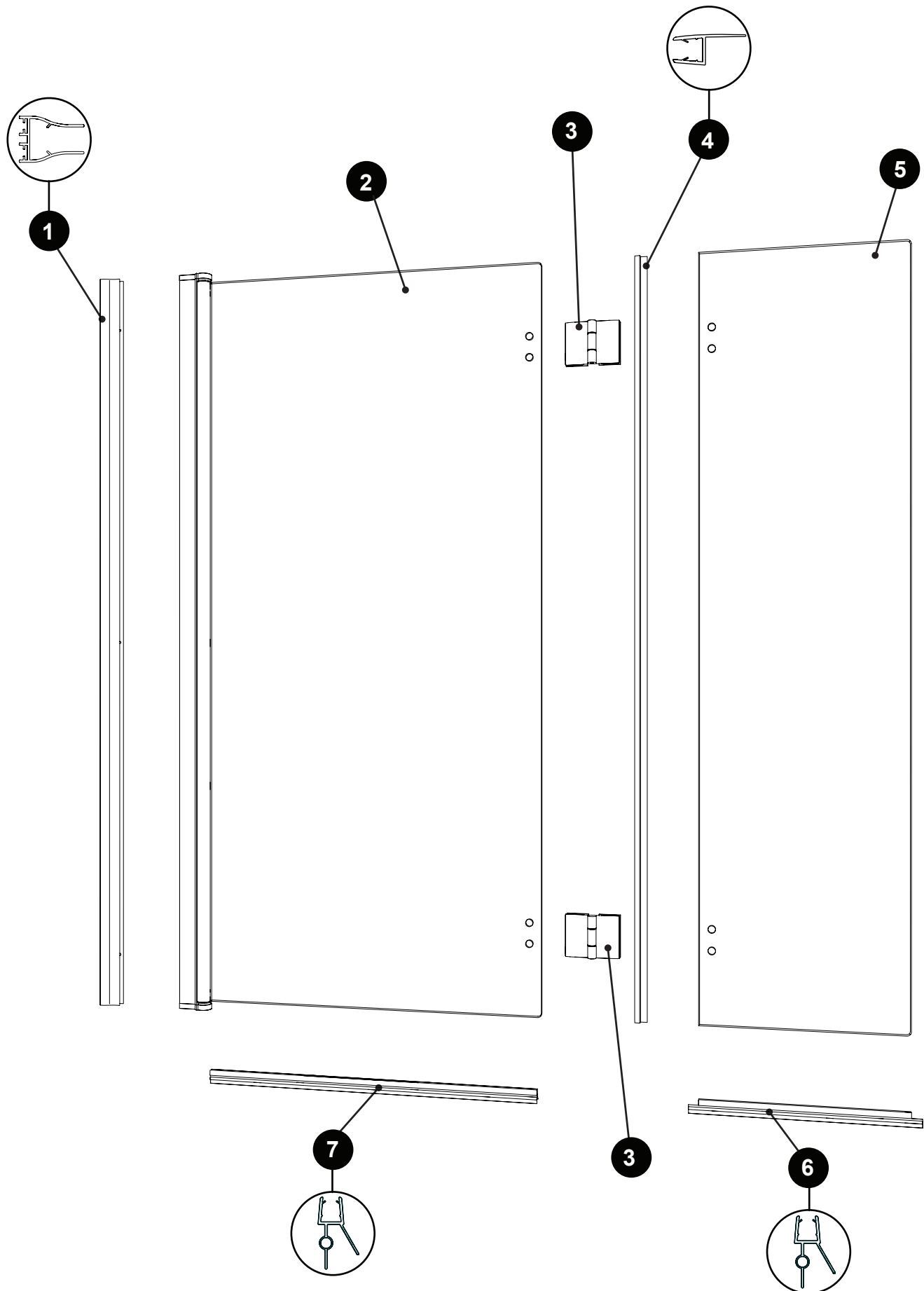

PARTS LISTING / LISTE DES PIÈCES



8

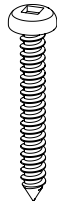

9



10



11

ITEM	PARTS AND HARDWARE / PIÈCES ET QUINCAILLERIE	QTY
1	WALL JAMB / JAMBAGE	1
2	PIVOT WITH FIXED PANEL / PANNEAU FIXE AVEC PIVOT	1
3	HINGE / CHARNIÈRE	2
4	SIDE GASKET / JOINT LATÉRAL	1
5	SMALL FIXED PANEL / PETIT PANNEAU FIXE	1
6	SHORT BOTTOM GASKET / JOINT INFÉRIEUR COURT	1
7	LONG BOTTOM GASKET / JOINT INFÉRIEUR LONG	1
8	WALL PLUG / CHEVILLE	3
9	WALL SCREW #8 - 1 ¼" / VIS MURAL #8 - 1 ¼"	3
10	SELF DRILLING PANHEAD SCREWS #8 - ¾" / VIS À TÊTE PAN AUTO-PERÇANTE #8 - ¾"	3
11	SCREW CAP / CAPUCHON COUVRE-VIS	3



THE INSTALLATION SHOWN IS BASED ON PLUMB FINISHED WALLS AND A LEVELLED BASE. IF THESE CONDITIONS ARE NOT MET, PLEASE ADJUST ACCORDINGLY.

L'INSTALLATION ILLUSTRÉE EST BASÉE SUR DES MURS FINIS D'APLOMB ET UNE BASE DE DOUCHE NIVELÉE. SI CES CONDITIONS NE SONT PAS PRÉSENTÉES, VEUILLEZ AJUSTER EN CONSÉQUENCE.

